

-1 BEARING RETAINER

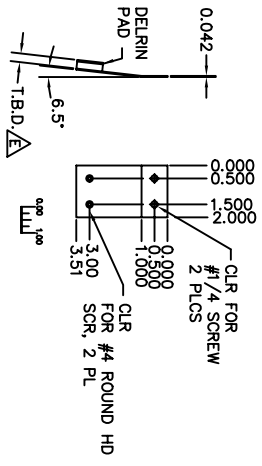

-2 SPRING ASSY

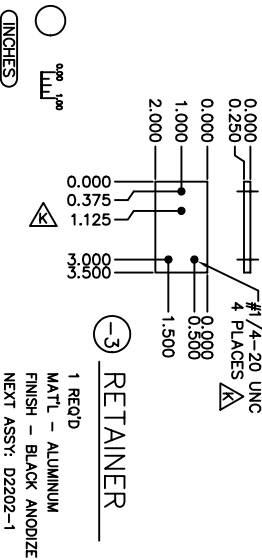

-3 RETAINER

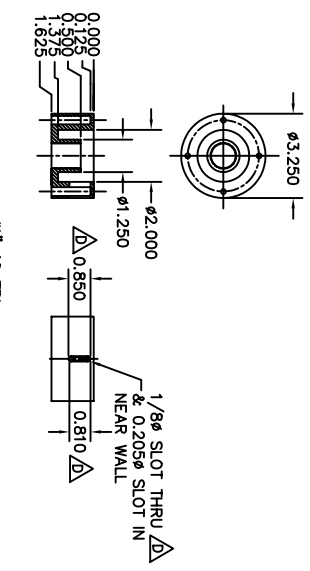

-4B RADIAL SUPPORT HOUSING

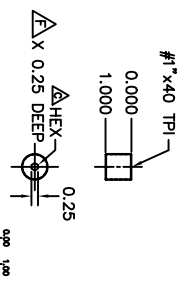

-6A RADIAL SCREW

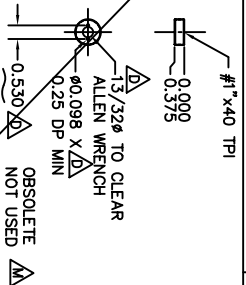

-6B RADIAL LOCK

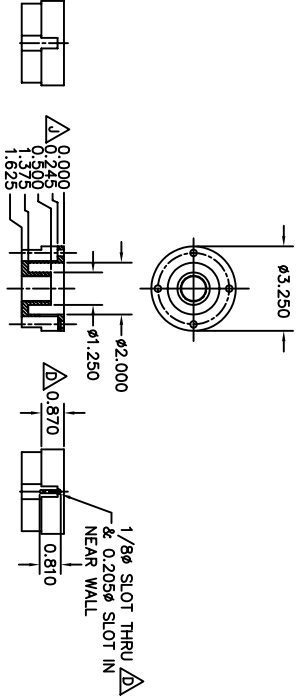

-4A RADIAL SUPPORT HOUSING

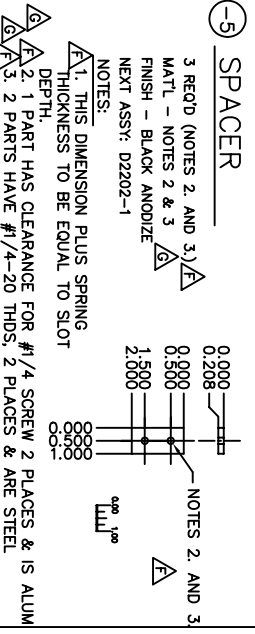

-5 SPACER



REV	DATE	BY	CHKD	DESCRIPTION
F	15.03.00	LO	LO	ISSUE TO REV. FROM
G	15.03.00	LO	LO	UPDATE TO REV. FROM
H	15.03.00	LO	LO	UPDATE TO REV. FROM
I	15.03.00	LO	LO	UPDATE TO REV. FROM
J	15.03.00	LO	LO	UPDATE TO REV. FROM
K	15.03.00	LO	LO	UPDATE TO REV. FROM
L	15.03.00	LO	LO	UPDATE TO REV. FROM
M	15.03.00	LO	LO	UPDATE TO REV. FROM

REV	DATE	BY	CHKD	DESCRIPTION
A	15.03.00	LO	LO	ISSUE TO REV. FROM
B	15.03.00	LO	LO	UPDATE TO REV. FROM
C	15.03.00	LO	LO	UPDATE TO REV. FROM
D	15.03.00	LO	LO	UPDATE TO REV. FROM
E	15.03.00	LO	LO	UPDATE TO REV. FROM
F	15.03.00	LO	LO	UPDATE TO REV. FROM
G	15.03.00	LO	LO	UPDATE TO REV. FROM
H	15.03.00	LO	LO	UPDATE TO REV. FROM
I	15.03.00	LO	LO	UPDATE TO REV. FROM
J	15.03.00	LO	LO	UPDATE TO REV. FROM
K	15.03.00	LO	LO	UPDATE TO REV. FROM
L	15.03.00	LO	LO	UPDATE TO REV. FROM
M	15.03.00	LO	LO	UPDATE TO REV. FROM

N.A.

KECK/DEMOS
COLLIMATOR
MIRROR CELL DETAILS
D2206.M